

PM pump

Features and Strengths

Highly operational reliability despite fluctuating or low compressed-air pressure
Various connection ports
Durable aluminum body

Advantages

Excellent performance in application that the large vacuum flow is needed
Reliable and stable operation - High vacuum level and vacuum flow in efficient air consumption
Optional Air-saving kit (AS-KIT) to minimize energy consumption

Application





Overall of specification

Model	Max. Vacuum level (- kPa)	Max. Feed Pressure (bar)	Max. Vacuum Flow (NI/m)	Air Consumption (NI/m)
PM303x1	92	7	341	158
PM303x2	92	7	682	304
PM303x3	92	7	1023	456
PM303x4	92	7	1364	608
PML303x1	75	7	362	104
PML303x2	75	7	724	208
PML303x3	75	7	1086	312
PML303x4	75	7	1448	416

VACUUM PUMPS / Premium pumps

PM pump

VMECA PM pump be combined with the optional Vacuum On/Off control valve, vacuum release valve and vacuum switch to create an optimal vacuum solution for many applications where the high vacuum flow required.

VMECA PM pump and optional components has been widely Used in automation field due to design which is easily mounted and can be simply replaced with classic pumps without changing dimensions



Key advantages

- VMECA vacuum cartridge integrated
- Fast response time with high vacuum flow
- Durable aluminum body



Applications

VMECA PREMIUM VACUUM PUMP (PM pump) can be mounted directly inline to save space and is suitable for applications requiring high suction flows or evacuation of large volumes of air (i.e. vacuum chamber)

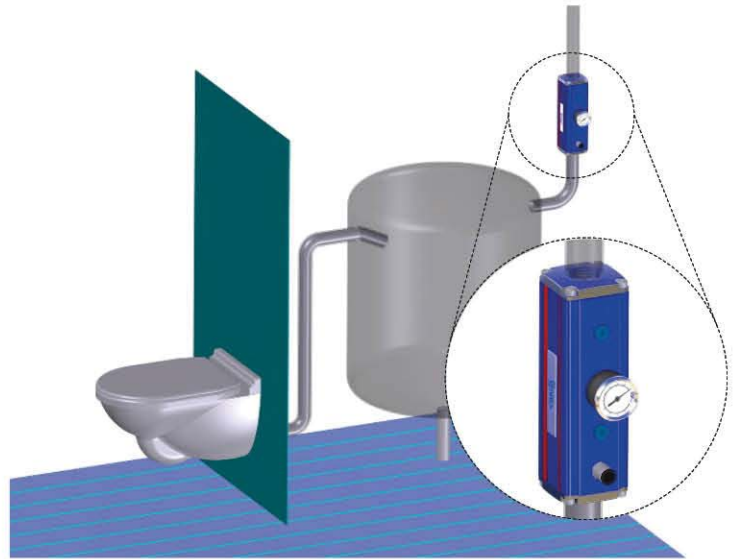

Despite fluctuations and drops in air pressure, PREMIUM PUMP maintains a high flow rate along with a high and stable vacuum level eliminating lost or interrupted cycles. This pump is excellent for non-sealed system applications or where large suction cups are used.

VMECA PREMIUM VACUUM PUMP can directly replace Classic Vacuum Pump without any change of mounting holes or brackets.

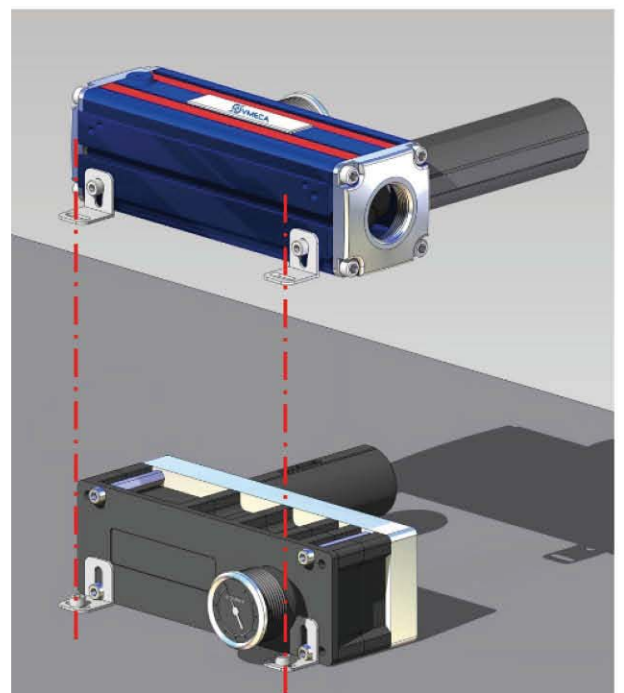

VACUUM PUMPS / Premium pumps

PM / PML 303x1

Features and Strengths

- Highly operational reliability despite fluctuating or low compressed-air pressure
- Top and side vacuum connection ports available
- Optional Air-Saving Kit available to minimize energy consumption
- Quick response time
- Strong aluminum body



Specifications

Description	PM303x1	PML303x1
Max. Vacuum level	-92 kPa	-75 kPa
Open Vacuum flow	341 NI/min	362 NI/min
Max. Feed pressure	7 bar	7 bar
Temperature	-20 ~ 80 °C	-20 ~ 80 °C
Noise level	60 ~ 65 dbA	60 ~ 65 dbA
Weight	1,528 g	1,527 g

Vacuum Flow

Model	Max. vacuum (-kPa)	Feed Pressure (bar)	Vacuum flow (NI/min) at different vacuum levels (-kPa)									
			0	10	20	30	40	50	60	70	80	90
PM303x1	75	2.2	302	122.5	88	53	31.4	28.5	16.5	4.6	-	-
	92	3.0	338	152	106	64	33	32	22	16.5	6.4	1.9
	92	4.0	341	154	127.5	94	69	43	23.3	17.3	6.9	2.1
PML303x1	60	4.0	302	172	110	70	46	28	6.8	-	-	-
	70	5.0	344	196	130	82	50	37.5	23	11.3	-	-
	75	6.0	362	207	154	100	52	38	32	22	-	-

Evacuation Time

Model	Feed Pressure (bar)	Air Consumption (NI/min)	Evacuation time in sec / liter to reach different vacuum levels (-kPa)									
			10	20	30	40	50	60	70	80	90	
PM303x1	2.2	97	0.019	0.09	0.1	0.32	0.42	0.73	1.62	-	-	
	3.0	118	0.015	0.07	0.18	0.28	0.38	0.64	0.8	12	3.8	
	4.0	152	0.01	0.48	0.07	0.09	0.2	0.42	0.8	1	3.4	
PML303x1	4.0	70	0.028	0.09	0.17	0.29	0.38	0.8	-	-	-	
	5.0	85	0.013	0.08	0.15	0.25	0.3	0.4	0.8	-	-	
	6.0	104	0.012	0.07	0.12	0.2	0.28	0.36	0.6	-	-	

Blow flow

Model	Feed Pressure (bar)	Air Consumption (NI/min)	Blow flow, NI/min, at different internal pressure levels (-kPa)											
			10	20	40	60	70	80	90	100	110	120	130	140
PM303x1	6.0	210	572	387	359	315	280	272	274	271	269	259	242	225

Model	Feed Pressure (bar)	Air Consumption (NI/min)	Blow flow, NI/min, at different internal pressure levels (-kPa)							
			0	10	20	30	40	50	60	70
PML303x1	6.0	104	470	320	272	225	196	189	165	140



PM / PML 303x2

Features and Strengths

- Highly operational reliability despite fluctuating or low compressed-air pressure
- Various connection ports
- Optional Air-Saving Kit available to minimize energy consumption
- Quick response time
- Strong aluminum body



Specifications

Description	PM303x2	PML303x2
Max. Vacuum level	-92 kPa	-75 kPa
Open Vacuum flow	682 NI/min	724 NI/min
Max. Feed pressure	7 bar	7 bar
Temperature	-20 ~ 80 °C	-20 ~ 80 °C
Noise level	60 ~ 65 dbA	60 ~ 65 dbA
Weight	1,523 g	1,523 g

Vacuum Flow

Model	Max. vacuum (-kPa)	Feed Pressure (bar)	Vacuum flow (NI/min) at different vacuum levels (-kPa)									
			0	10	20	30	40	50	60	70	80	90
PM303x2	75	2.2	604	245	176	106	62.8	57	33	9.2	-	-
	92	3.0	676	304	212	128	66	64	44	3.3	12.8	3.8
	92	4.0	682	308	255	188	138	86	46.6	34.6	13.8	4.2
PML303x2	60	4.0	604	344	220	140	92	56	13.6	-	-	-
	70	5.0	688	392	260	164	100	75	46	23.8	-	-
	75	6.0	724	415	308	200	104	76	64	44	-	-

Evacuation Time

Model	Feed Pressure (bar)	Air Consumption (NI/min)	Evacuation time in sec / liter to reach different vacuum levels (-kPa)									
			10	20	30	40	50	60	70	80	90	
PM303x2	2.2	194	0.011	0.043	0.05	0.17	0.23	0.38	0.81	-	-	
	3.0	236	0.01	0.032	0.045	0.15	0.22	0.33	0.48	0.78	1.98	
	4.0	304	0.01	0.026	0.037	0.047	0.12	0.23	0.35	0.7	1.72	
PML303x2	4.0	140	0.017	0.037	0.073	0.14	0.19	0.45	-	-	-	
	5.0	170	0.014	0.032	0.06	0.128	0.16	0.25	0.43	-	-	
	6.0	208	0.012	0.03	0.047	0.098	0.15	0.2	0.32	-	-	

Blow flow

Model	Feed Pressure (bar)	Air Consumption (NI/min)	Blow flow, NI/min, at different internal pressure levels (-kPa)											
			10	20	40	60	70	80	90	100	110	120	130	140
PM303x2	6.0	420	1144	774	718	630	560	544	548	542	538	518	484	450

Model	Feed Pressure (bar)	Air Consumption (NI/min)	Blow flow, NI/min, at different internal pressure levels (-kPa)							
			0	10	20	30	40	50	60	70
PML303x2	6.0	208	940	640	544	450	392	378	330	280



PM / PML 303x3

Features and Strengths

- Highly operational reliability despite fluctuating or low compressed-air pressure
- Various connection ports
- Optional Air-Saving Kit available to minimize energy consumption
- Quick response time
- Strong aluminum body



Specifications

Description	PM303x3	PML303x3
Max. Vacuum level	-92 kPa	-75 kPa
Open Vacuum flow	1,023 NI/min	1,086 NI/min
Max. Feed pressure	7 bar	7 bar
Temperature	-20 ~ 80 °C	-20 ~ 80 °C
Noise level	60 ~ 65 dbA	60 ~ 65 dbA
Weight	1,519 g	1,519 g

Vacuum Flow

Model	Max. vacuum (-kPa)	Feed Pressure (bar)	Vacuum flow (NI/min) at different vacuum levels (-kPa)									
			0	10	20	30	40	50	60	70	80	90
PM303x3	75	2.2	902	368	264	159	94	86	50	14	-	-
	92	3.0	1014	456	318	192	99	96	66	50	19	6
	92	4.0	1023	462	383	282	207	129	70	52	21	6.3
PML303x3	60	4.0	906	516	330	210	138	84	20.4	-	-	-
	70	5.0	1032	588	390	246	150	112.5	69	34	-	-
	75	6.0	1086	621	462	300	156	114	96	66	-	-

Evacuation Time

Model	Feed Pressure (bar)	Air Consumption (NI/min)	Evacuation time in sec / liter to reach different vacuum levels (-kPa)									
			10	20	30	40	50	60	70	80	90	
PM303x3	2.2	291	0.006	0.03	0.038	0.1	0.14	0.24	0.54	-	-	
	3.0	354	0.005	0.02	0.03	0.09	0.12	0.21	0.24	0.4	1.27	
	4.0	456	0.004	0.01	0.02	0.03	0.06	0.14	0.2	0.33	1.13	
PML303x3	4.0	210	0.016	0.03	0.085	0.09	0.12	0.26	-	-	-	
	5.0	255	0.0085	0.028	0.05	0.08	0.1	0.13	0.26	-	-	
	6.0	312	0.0079	0.02	0.04	0.06	0.09	0.12	0.2	-	-	

Blow flow

Model	Feed Pressure (bar)	Air Consumption (NI/min)	Blow flow, NI/min, at different internal pressure levels (-kPa)											
			10	20	40	60	70	80	90	100	110	120	130	140
PM303x3	6.0	630	1716	1161	1077	945	840	816	822	813	807	777	747	675

Model	Feed Pressure (bar)	Air Consumption (NI/min)	Blow flow, NI/min, at different internal pressure levels (-kPa)							
			0	10	20	30	40	50	60	70
PML303x3	6.0	312	1404	966	822	678	589	564	492	416



PM / PML 303x4

Features and Strengths

- Highly operational reliability despite fluctuating or low compressed-air pressure
- Various connection ports
- Optional Air-Saving Kit available to minimize energy consumption
- Quick response time
- Strong aluminum body



Specifications

Description	PM303x4	PML303x4
Max. Vacuum level	-92 kPa	-75 kPa
Open Vacuum flow	1,364 NI/min	1,448 NI/min
Max. Feed pressure	7 bar	7 bar
Temperature	-20 ~ 80 °C	-20 ~ 80 °C
Noise level	60 ~ 65 dbA	60 ~ 65 dbA
Weight	1,516 g	1,515 g

Vacuum Flow

Model	Max. vacuum (-kPa)	Feed Pressure (bar)	Vacuum flow (NI/min) at different vacuum levels (-kPa)									
			0	10	20	30	40	50	60	70	80	90
PM303x4	75	2.2	1208	490	352	212	126	114	66	18	-	-
	92	3.0	1352	608	424	256	132	128	88	66	26	7.6
	92	4.0	1364	616	510	376	276	172	93	69	28	8.4
PML303x4	60	4.0	1208	688	440	280	184	112	27	-	-	-
	70	5.0	1376	784	520	328	200	150	92	45	-	-
	75	6.0	1448	828	616	400	208	152	128	88	-	-

Evacuation Time

Model	Feed Pressure (bar)	Air Consumption (NI/min)	Evacuation time in sec / liter to reach different vacuum levels (-kPa)									
			10	20	30	40	50	60	70	80	90	
PM303x4	2.2	388	0.005	0.02	0.027	0.08	0.1	0.18	0.4	-	-	
	3.0	472	0.004	0.018	0.02	0.07	0.09	0.16	0.2	0.3	0.95	
	4.0	608	0.003	0.01	0.01	0.02	0.05	0.1	0.15	0.25	0.85	
PML303x4	4.0	280	0.0089	0.023	0.04	0.07	0.09	0.2	-	-	-	
	5.0	340	0.0057	0.018	0.03	0.063	0.075	0.1	0.2	-	-	
	6.0	416	0.0053	0.015	0.029	0.052	0.071	0.09	0.15	-	-	

Blow flow

Model	Feed Pressure (bar)	Air Consumption (NI/min)	Blow flow, NI/min, at different internal pressure levels (-kPa)											
			10	20	40	60	70	80	90	100	110	120	130	140
PM303x4	6.0	840	2288	1548	1436	1260	1120	1088	1096	1084	1076	1036	968	900

Model	Feed Pressure (bar)	Air Consumption (NI/min)	Blow flow, NI/min, at different internal pressure levels (-kPa)							
			0	10	20	30	40	50	60	70
PML303x4	6.0	416	1868	1284	1096	904	784	752	656	556



VACUUM PUMPS / Premium pumps

Body type "A" Dimensions – Basic Pump

[Unit : mm]

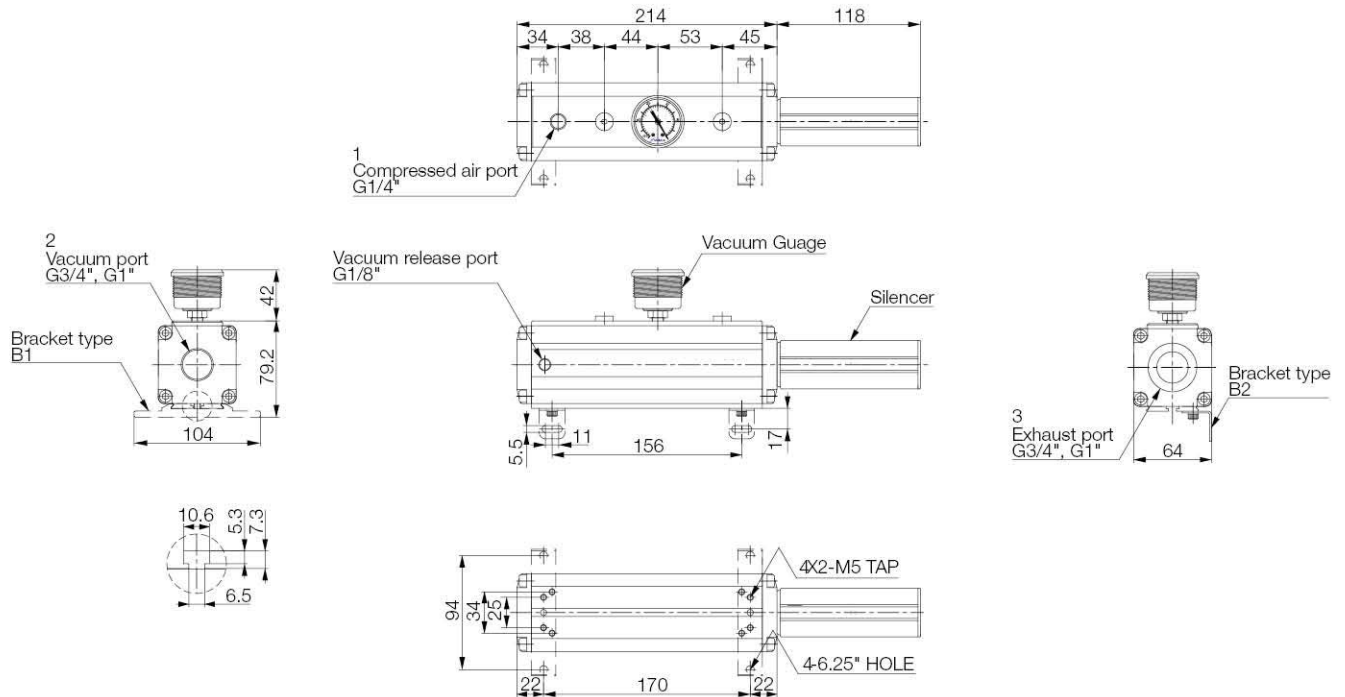

Body type "A" Dimensions – with Accessories

[Unit : mm]

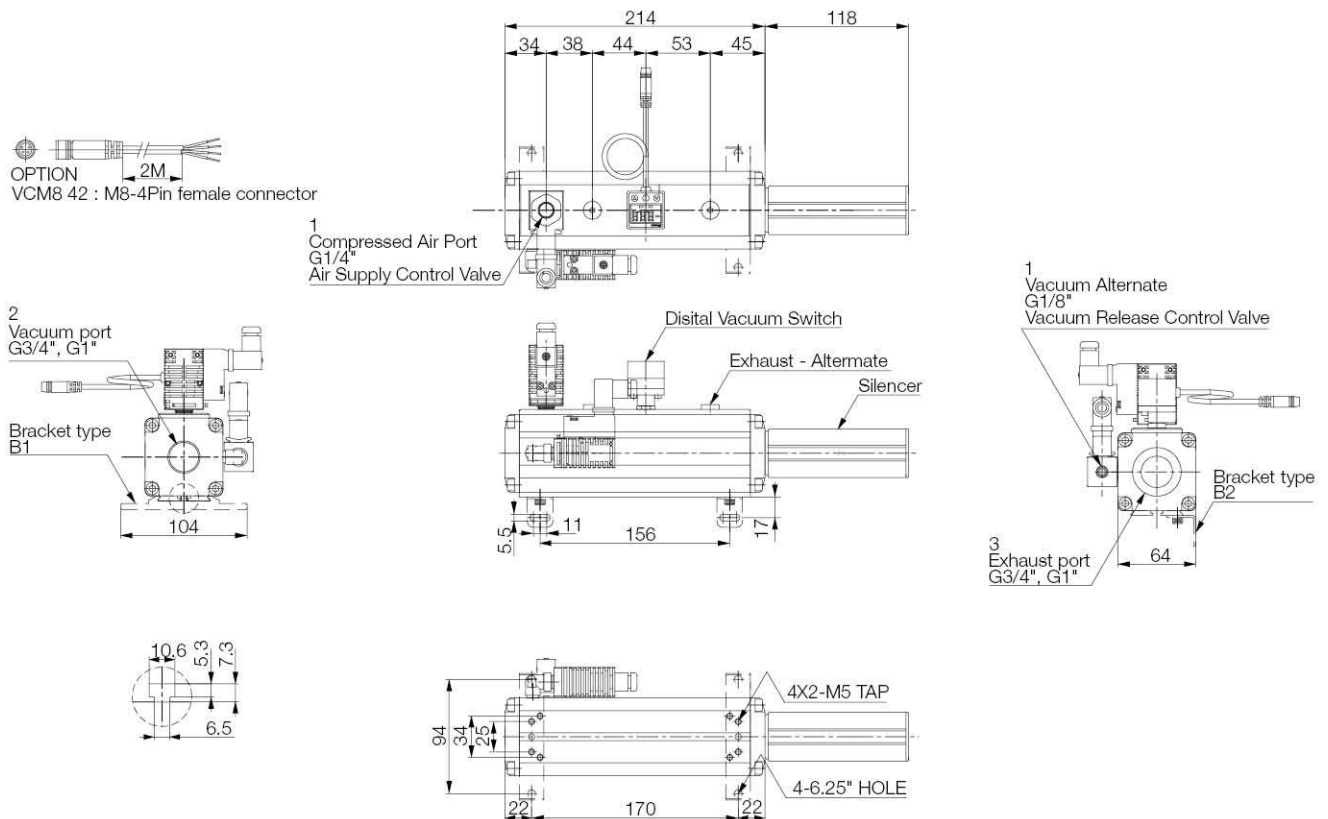

I Body type "B" Dimensions – Basic Pump

[Unit : mm]

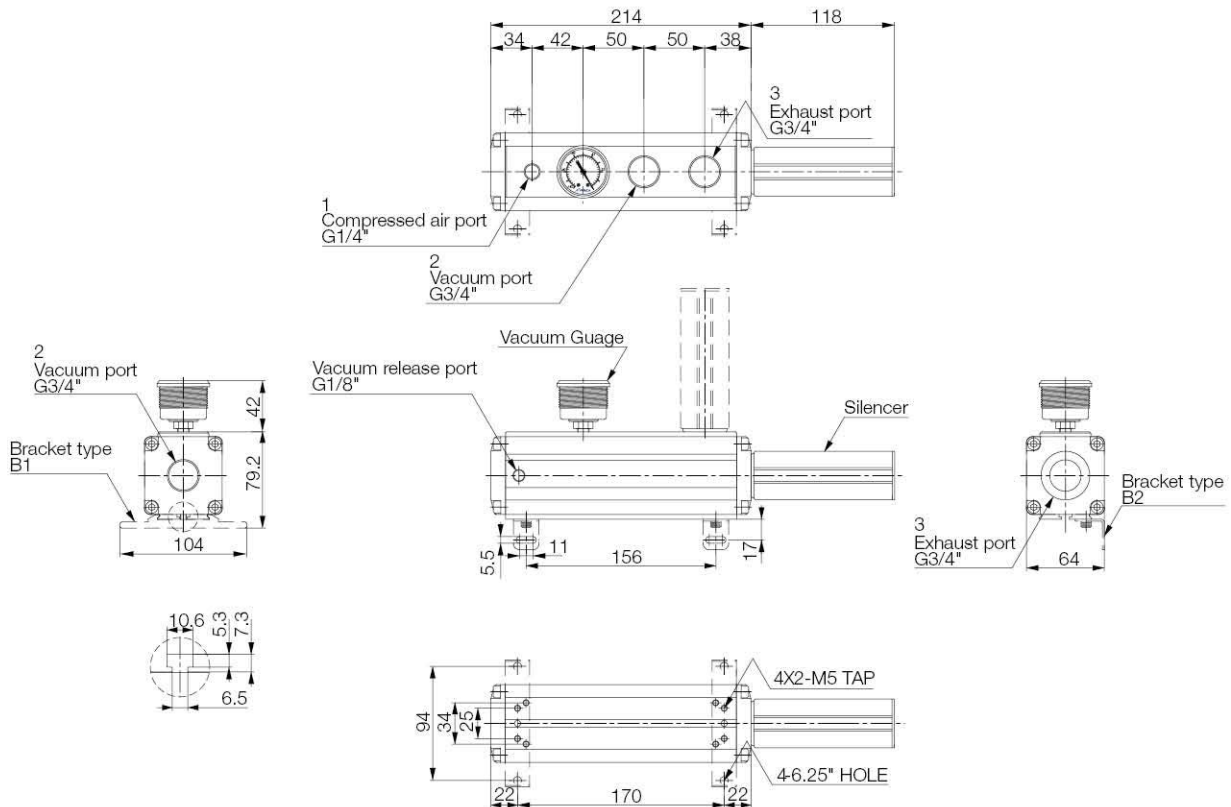

I Body type "B" Dimensions – with Accessories

[Unit : mm]

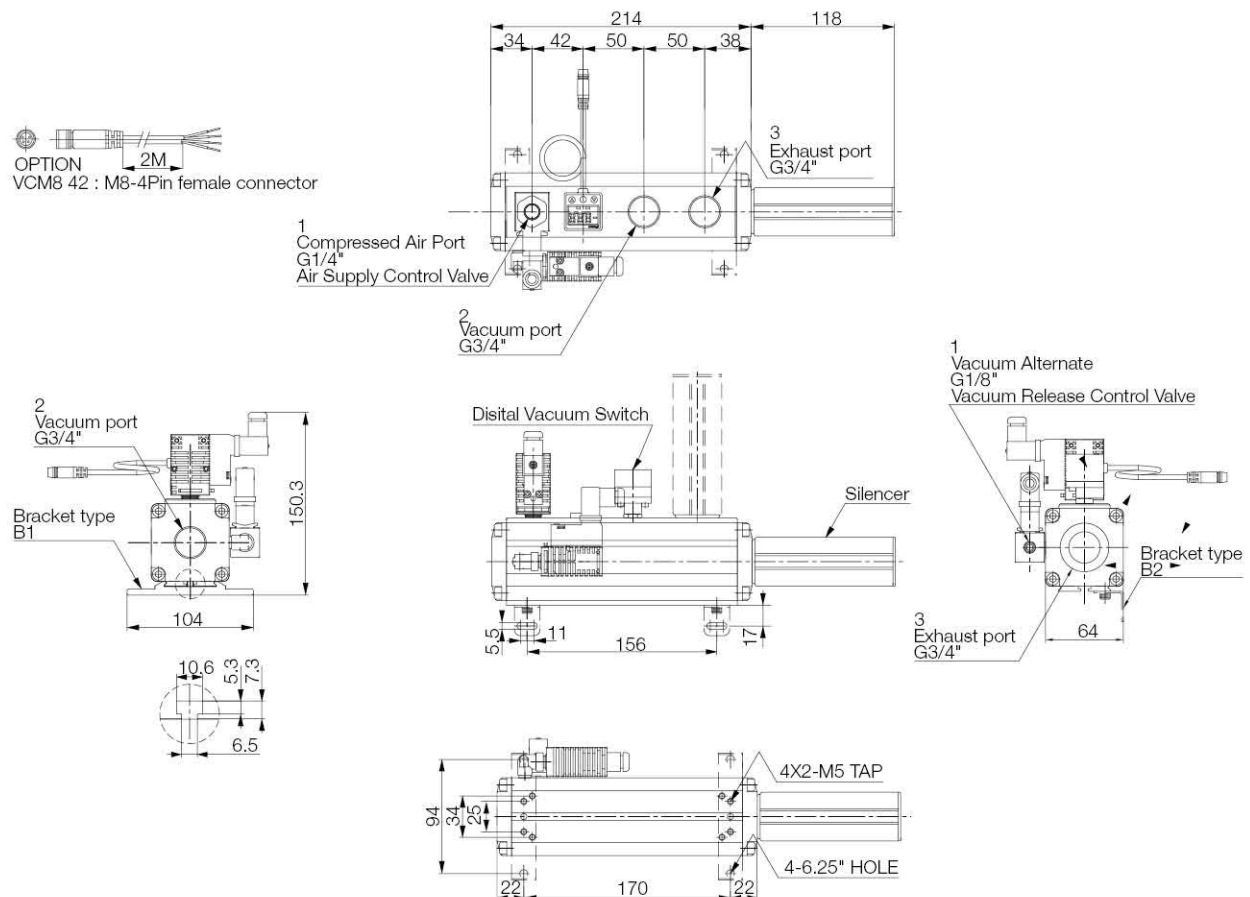

VACUUM PUMPS / Premium pumps

Performance data

PM303x1

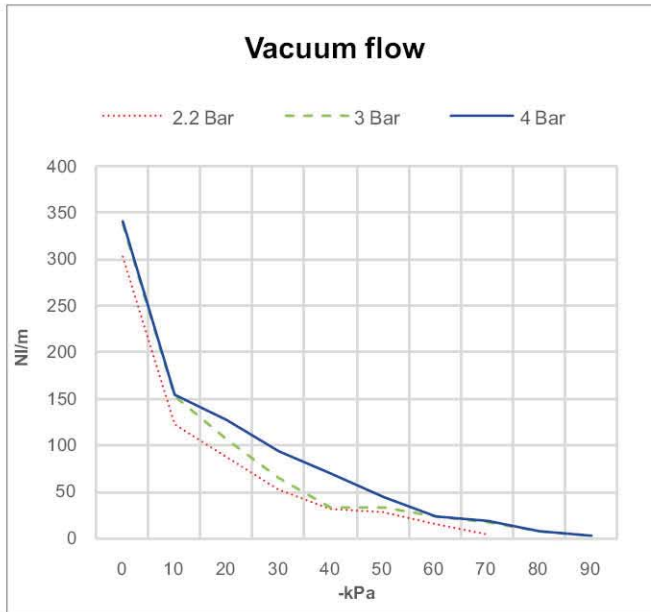

※ Vacuum flow at different vacuum level

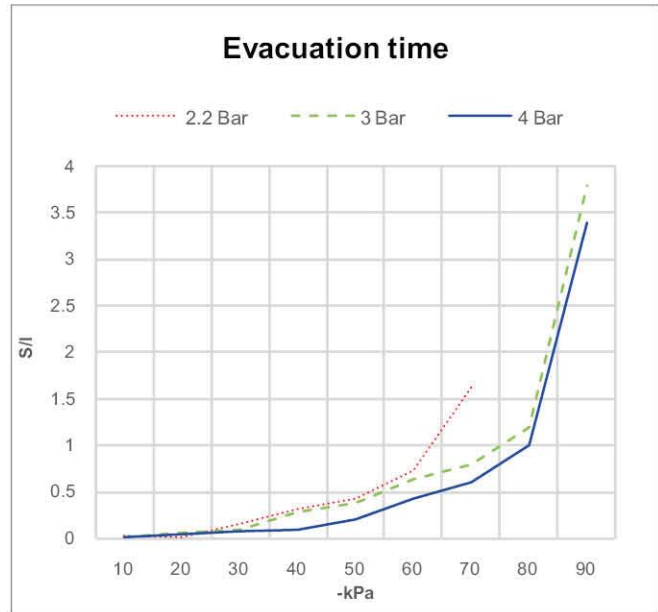

※ Time to evacuate a volume at different vacuum level

PML303x1

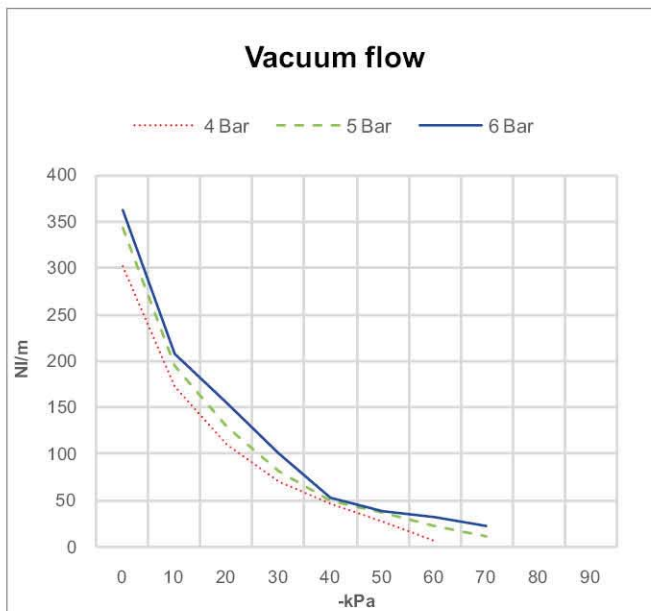

※ Vacuum flow at different vacuum level

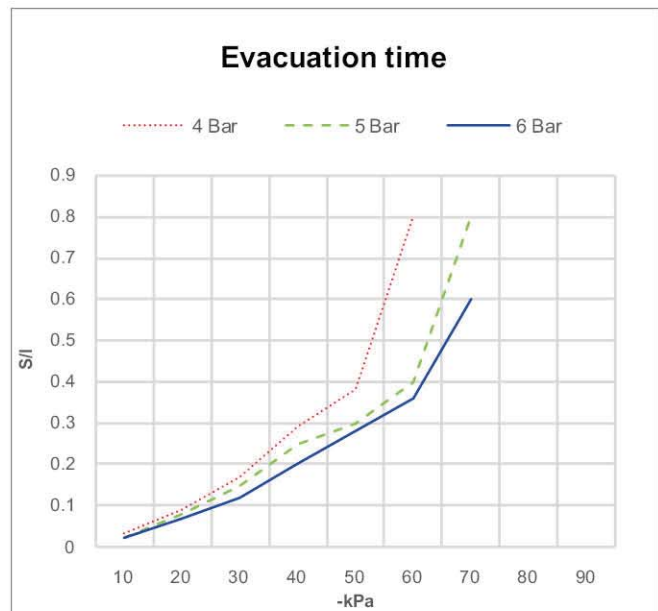

※ Time to evacuate a volume at different vacuum level



Performance data

PM303x2

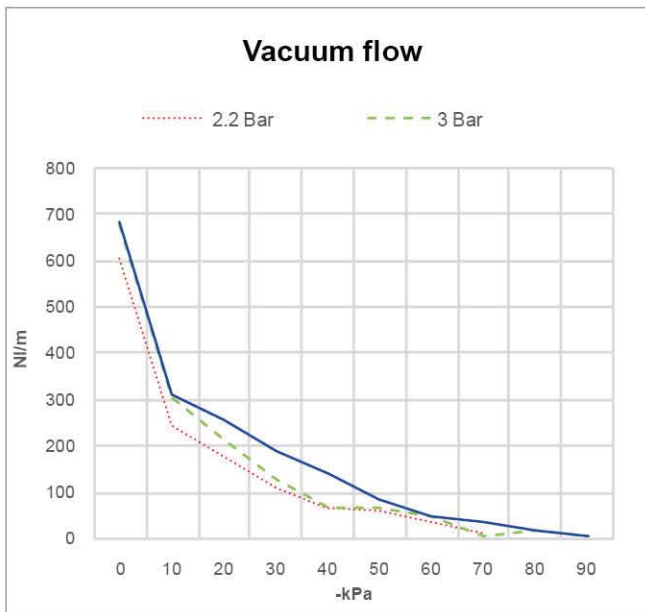

※ Vacuum flow at different vacuum level

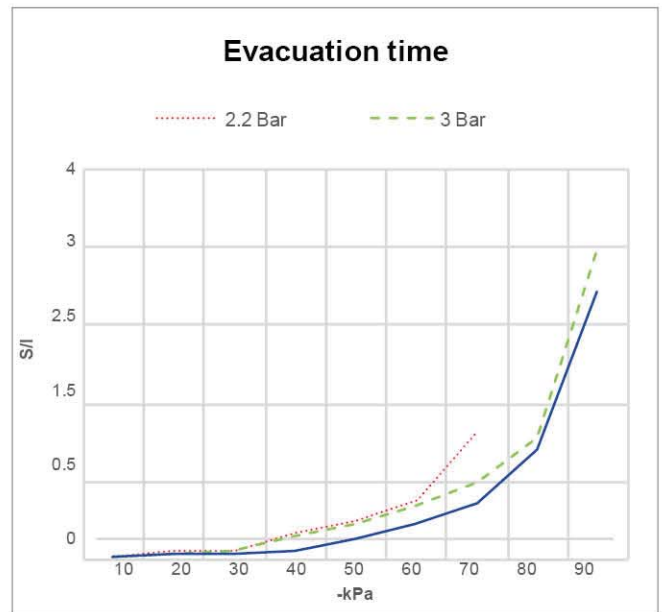

※ Time to evacuate a volume at different vacuum level

PML303x2

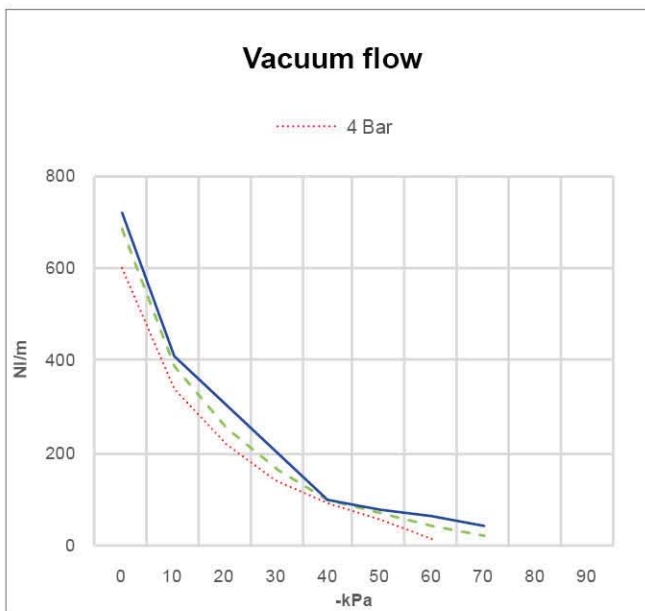

※ Vacuum flow at different vacuum level

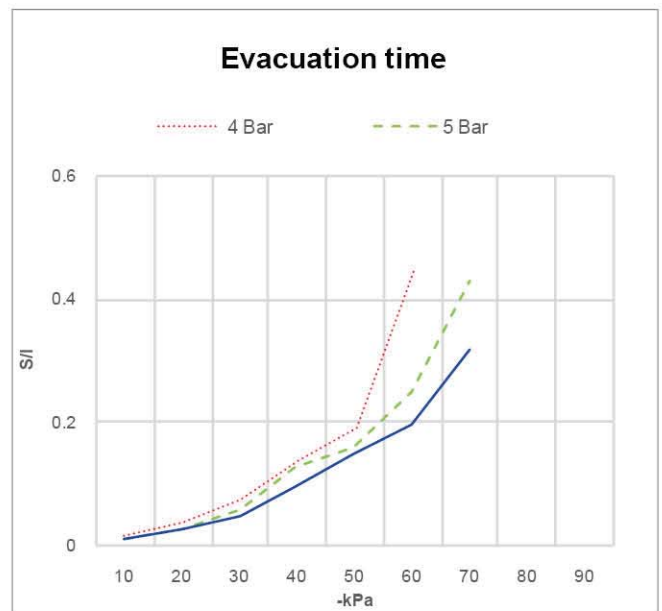

※ Time to evacuate a volume at different vacuum level

VACUUM PUMPS / Premium pumps

Performance data

PM303x3

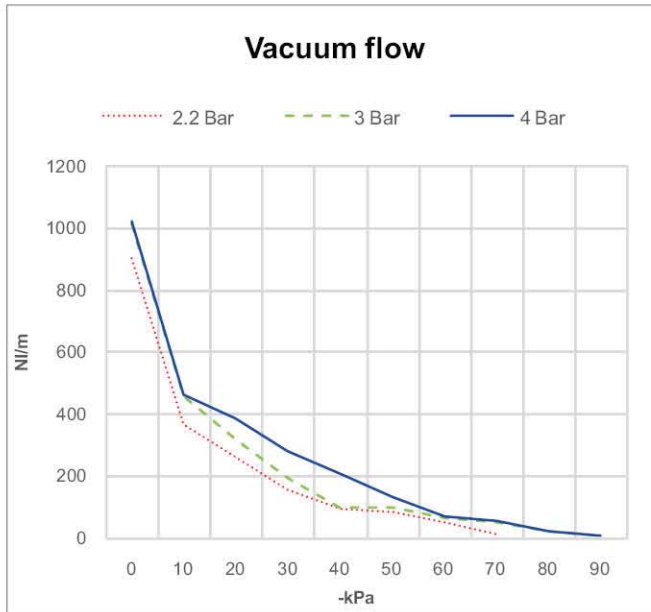

※ Vacuum flow at different vacuum level

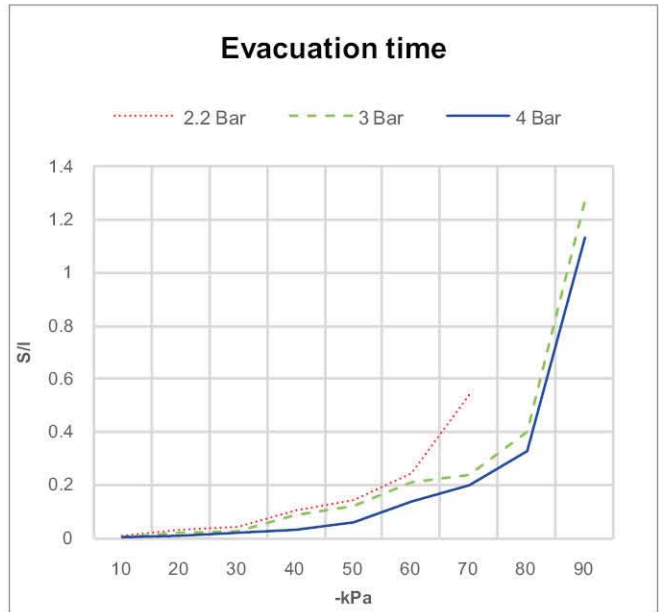

※ Time to evacuate a volume at different vacuum level

PML303x3

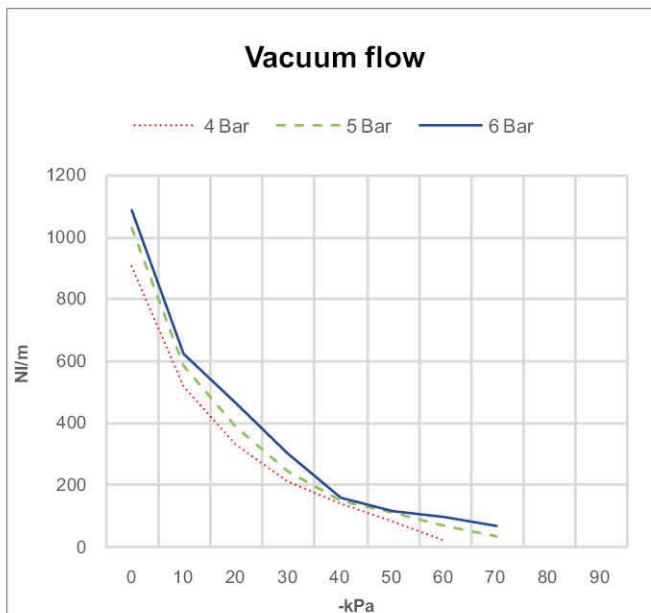

※ Vacuum flow at different vacuum level

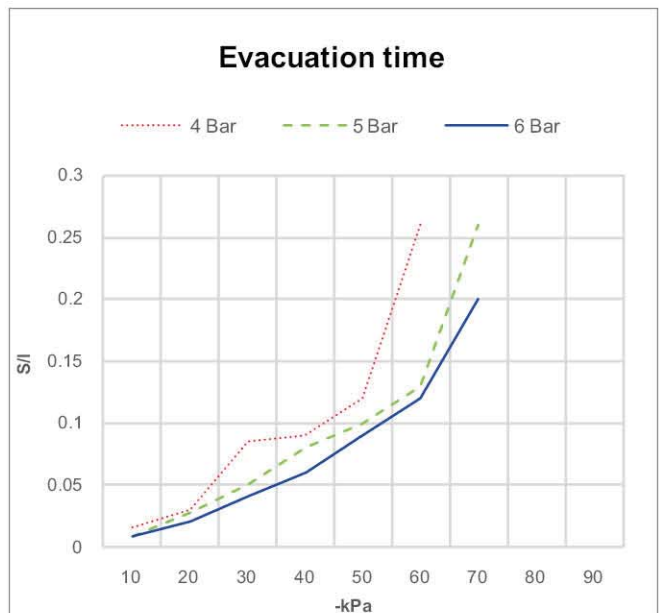

※ Time to evacuate a volume at different vacuum level



Performance data

PM303x4

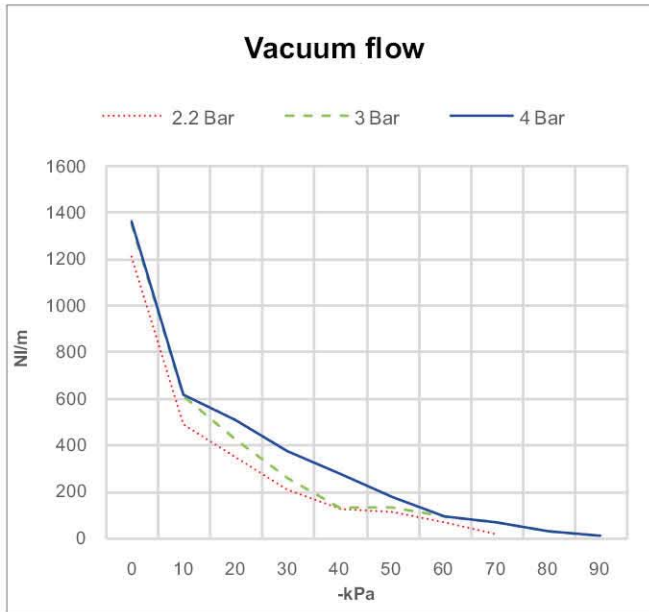

※ Vacuum flow at different vacuum level

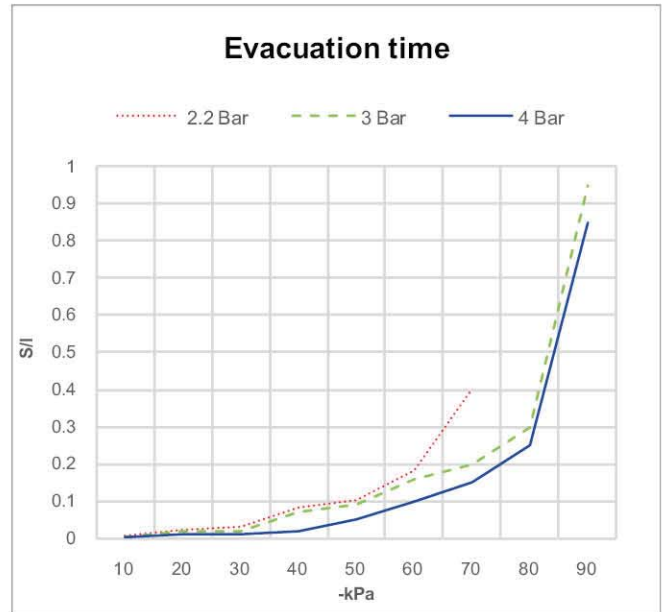

※ Time to evacuate a volume at different vacuum level

PML303x4

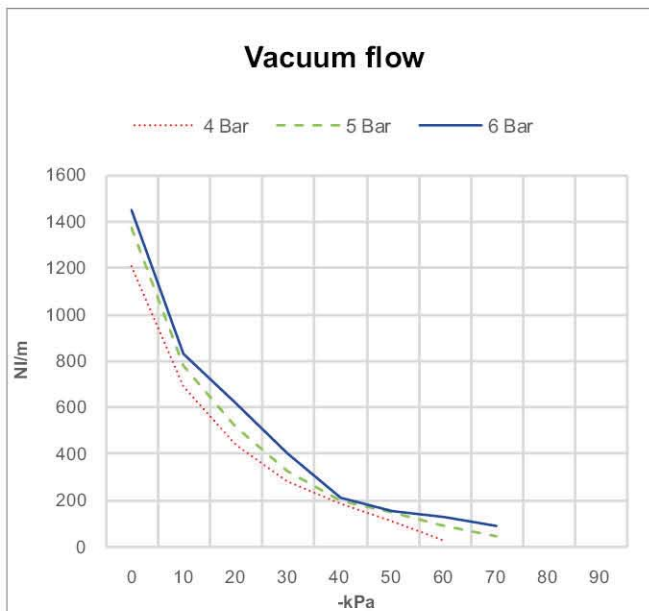

※ Vacuum flow at different vacuum level

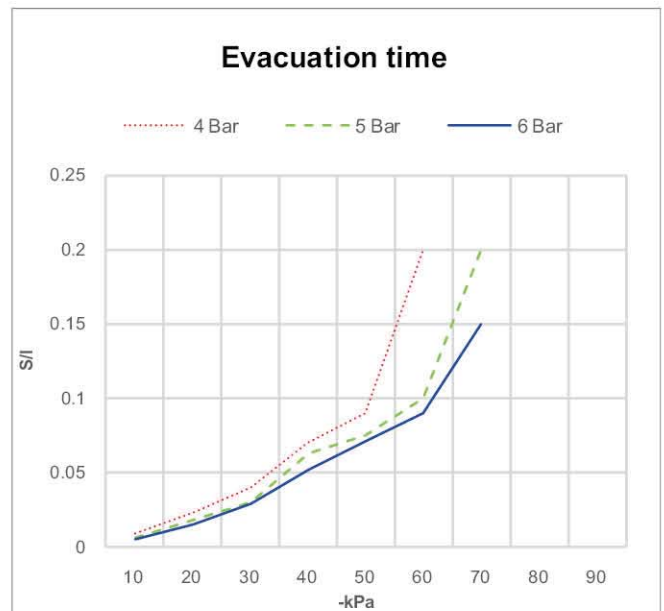

※ Time to evacuate a volume at different vacuum level

VACUUM PUMPS / Premium pumps

I Build an Ordering No.

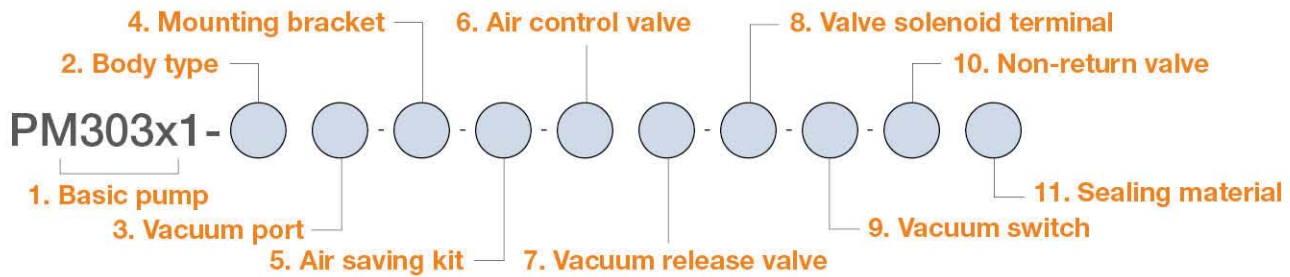

1. Basic pump	Description	Symbol
	PM Pump, 3-Stage, 1-vacuum cartridge, Silencer	PM303x1
	PM Pump, 3-Stage, 2-vacuum cartridge, Silencer	PM303x2
	PM Pump, 3-Stage, 3-vacuum cartridge, Silencer	PM303x3
	PM Pump, 3-Stage, 4-vacuum cartridge, Silencer	PM303x4
	PM Pump, 3-Stage "L" cartridge, 1-vacuum cartridge, Silencer	PML303x1
	PM Pump, 3-Stage "L" cartridge, 2-vacuum cartridge, Silencer	PML303x2
	PM Pump, 3-Stage "L" cartridge, 3-vacuum cartridge, Silencer	PML303x3
	PM Pump, 3-Stage "L" cartridge, 4-vacuum cartridge, Silencer	PML303x4
2. Body type	Description	Symbol
	Vacuum port on side	A
	Vacuum ports on top and side	B
3. Vacuum port	Description	Symbol
	Vacuum port G3/4"	34
	Vacuum port G1"	01
	- Body type "B" is available only with vacuum port G3/4"	
4. Mounting bracket	Description	Symbol
	No mounting bracket	Blank
	4 points support	B1
	2 points support	B2
5. Air saving kit	Description	Symbol
	No air saving kit	Blank
	Air saving kit without air control valve	AS
	Air saving kit integrated with air control valve	ASV
6. Air control valve	Description	Symbol
	No air control valve	Blank
	Air control valve, AC110V	A1
	Air control valve, AC220V	A2
	Air control valve, DC24V	A3
	Double solenoid valve, AC110V	D1
	Double solenoid valve, AC220V	D2
	Double solenoid valve, DC24V	D3
7. Vacuum release valve	Description	Symbol
	No vacuum release valve	Blank
	Vacuum release valve, AC110V	R1
	Vacuum release valve, AC220V	R2
	Vacuum release valve, DC24V	R3
8. Valve solenoid terminal	Description	Symbol
	Solenoid Terminal, DIN, No LW	DN
	Solenoid Terminal, DIN, Lamp, No LW	DL
	Solenoid Terminal, Conn, Lamp & 0.3m LW: Only available with DC24V	CL
	Solenoid Terminal, DIN, 2 in 1 BUS cable: Not available with Double Solenoid Valve	2B
	Solenoid Terminal, DIN, 3 in 1 BUS cable: Not available with Double Solenoid Valve	3B
	Solenoid Terminal, DIN, 4 in 1 BUS cable: available with Double Solenoid Valve	4B
	- 3B and 4B are available only with DC24V and S2 or S2P vacuum switch	



Build an Ordering No.

9. Vacuum switch	Description	Symbol
	No vacuum switch	Blank
	Digital switch, No analog supply, M8-4pins, NPN	S2
	Digital switch, No analog supply, M8-4pins, PNP	S2P
	Digital switch, No analog supply, Grommet, NPN	SG2
	Digital switch, No analog supply, Grommet, PNP	SG2P
	Digital switch, Analog supply, Grommet, NPN	SG3
	Digital switch, Analog supply, Grommet, PNP	SG3P

10. Non-return valve	Description	Symbol
	No non-return valve	Blank
	Non-return valve: No need with Air saving kit	N

11. Sealing material	Description	Symbol
	NBR	Blank
	VITON	V
	EPDM	E

Spare Parts – Basic pumps

Part No.	Description	Weight (g)
PM303x1-A-34	PM Pump, 3-Stage, 1-vacuum cartridge, G3/4" vacuum port on side, Silencer	1,528
PM303x2-A-34	PM Pump, 3-Stage, 2-vacuum cartridge, G3/4" vacuum port on side, Silencer	1,523
PM303x3-A-34	PM Pump, 3-Stage, 3-vacuum cartridge, G3/4" vacuum port on side, Silencer	1,519
PM303x4-A-34	PM Pump, 3-Stage, 4-vacuum cartridge, G3/4" vacuum port on side, Silencer	1,516
PML303x1-A-34	PM Pump, 3-Stage "L" cartridge, 1-vacuum cartridge, G3/4" vacuum port on side, Silencer	1,527
PML303x2-A-34	PM Pump, 3-Stage "L" cartridge, 2-vacuum cartridge, G3/4" vacuum port on side, Silencer	1,523
PML303x3-A-34	PM Pump, 3-Stage "L" cartridge, 3-vacuum cartridge, G3/4" vacuum port on side, Silencer	1,519
PML303x4-A-34	PM Pump, 3-Stage "L" cartridge, 4-vacuum cartridge, G3/4" vacuum port on side, Silencer	1,515
PM303x1-B-34	PM Pump, 3-Stage, 1-vacuum cartridge, G3/4" vacuum ports on top & side, Silencer	1,499
PM303x2-B-34	PM Pump, 3-Stage, 2-vacuum cartridge, G3/4" vacuum ports on top & side, Silencer	1,495
PM303x3-B-34	PM Pump, 3-Stage, 3-vacuum cartridge, G3/4" vacuum ports on top & side, Silencer	1,490
PM303x4-B-34	PM Pump, 3-Stage, 4-vacuum cartridge, G3/4" vacuum ports on top & side, Silencer	1,486
PML303x1-B-34	PM Pump, 3-Stage "L" cartridge, 1-vacuum cartridge, G3/4" vacuum ports on top & side, Silencer	1,498
PML303x2-B-34	PM Pump, 3-Stage "L" cartridge, 2-vacuum cartridge, G3/4" vacuum ports on top & side, Silencer	1,494
PML303x3-B-34	PM Pump, 3-Stage "L" cartridge, 3-vacuum cartridge, G3/4" vacuum ports on top & side, Silencer	1,489
PML303x4-B-34	PM Pump, 3-Stage "L" cartridge, 4-vacuum cartridge, G3/4" vacuum ports on top & side, Silencer	1,484
PM303x1-A-01	PM Pump, 3-Stage, 1-vacuum cartridge, G1" vacuum port on side, Silencer	1,516
PM303x2-A-01	PM Pump, 3-Stage, 2-vacuum cartridge, G1" vacuum port on side, Silencer	1,513
PM303x3-A-01	PM Pump, 3-Stage, 3-vacuum cartridge, G1" vacuum port on side, Silencer	1,509
PM303x4-A-01	PM Pump, 3-Stage, 4-vacuum cartridge, G1" vacuum port on side, Silencer	1,504
PML303x1-A-01	PM Pump, 3-Stage "L" cartridge, 1-vacuum cartridge, G1" vacuum port on side, Silencer	1,516
PML303x2-A-01	PM Pump, 3-Stage "L" cartridge, 2-vacuum cartridge, G1" vacuum port on side, Silencer	1,512
PML303x3-A-01	PM Pump, 3-Stage "L" cartridge, 3-vacuum cartridge, G1" vacuum port on side, Silencer	1,507
PML303x4-A-01	PM Pump, 3-Stage "L" cartridge, 4-vacuum cartridge, G1" vacuum port on side, Silencer	1,502

Spare Parts – Cartridges & Silencer

Part No.	Description	Weight (g)
VC303	Midi Vacuum Cartridge, 3-Stage for PM303	24.08
VCL303	Midi Vacuum Cartridge, "L" Series, 3-Stage for PML303	24.72
VTS-34	Free flow silencer, G3/4"	52.37