

PUSH-IN FITTINGS OTR SERIES

PLUS

HIGH PERFORMANCE FITTINGS, easy to use

STRONG but **COMPACT** in order to ensure the maximum assembling flexibility

COMPLETE RANGE suitable to be used with different kinds of tubing

ELECTROLYTIC NICKEL PLATING to ensure the maximum duration over time

STATIC GRIPPING SYSTEM in order to stop all movement of the tube when inserted, granting a **A LEAK-PROOF CONNECTION**

Every fitting is **DESIGNED TO GUARANTEE THE MAXIMUM POSSIBLE FLOW RATE** according to the diameter of the tube and of the thread

PRODUCTS CAN BE TAILOR-MADE TO SPECIFIC CUSTOMER NEEDS



p. 5 / **OTRC-R**



p. 5 / **OTRC-G**



6 / **OTRC-N**



p. 6 / **OTROC-G**



p. 7 / **OTROC-N**



p. 7 / **OTRCF-G**



p. 7 / **OTRMM**



p. 7 / **OTRME**



p. 8 / **OTRL-R**



p. 8 / **OTRL-G**



p. 9 / **OTRL-N**



p. 9 / **OTRLF-G**



p. 9 / **OTRT-R**



p. 10 / **OTRT-G**



p. 10 / **OTRT-N**



p. 11 / **OTRST-R**



p. 11 / **OTRST-G**



p. 12 / **OTRA-G**



p. 12 / **OTRUC**



p. 13 / **OTRUL**



p. 13 / **OTRUT**



p. 14 / **OTRY**



p. 14 / **OTRGJ**



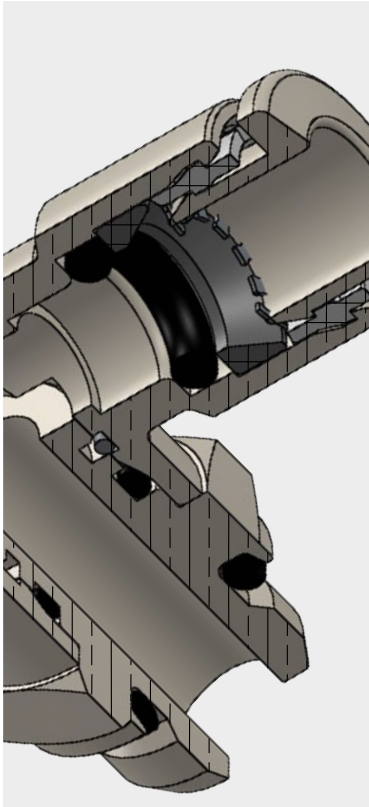

-20°C ÷ 80°C



Working pressure:

20 Bar



Negative pressure:

-0,95 Bar (- 95 kPa)



Compressed air & Vacuum



- Taper gas BSPT ISO 7 from R1/8" to R1/2"
- Parallel gas BSPP ISO 228 from G1/8" to G1/2"
- Metric ISO 262 M5 and M7
- NPT ANSI B 1.20.1 from N1/8" to N1/2"
- UNF ANSI B 1.1 10-32 UF



Polyamide PA,
Polyurethane PU,
Polyethylene PE

- Body:** Nickel-plated brass
- Turning: UNI EN 12164 CW614N
- Hot forging & machining: UNI EN 12164 CW617N
- Collar:** POM
- Collet:** Nickel-plated brass
UNI EN 12164 CW614N
- Lock claw:** Stainless steel AISI 301
- Back ring:** PBT
- O-ring:** NBR silicone free
- Seal:** NBR silicone free
- Retaining ring for swivel systems:** Stainless steel AISI 302



SILICONE FREE



Products in compliance with EC Regulation 1907/2006

RoHS3

Products in compliance with the directive EU 2015/863

CONSTRUCTION DETAILS

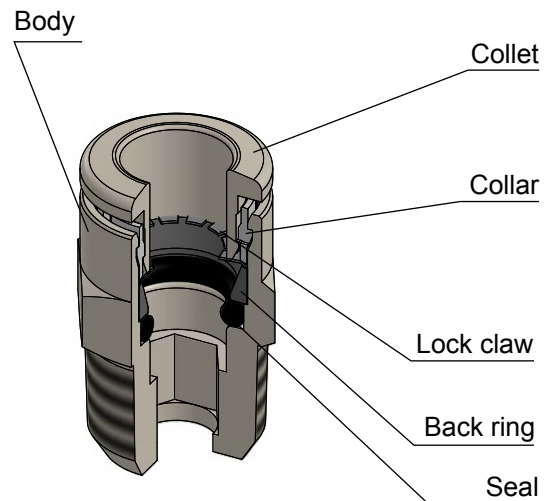
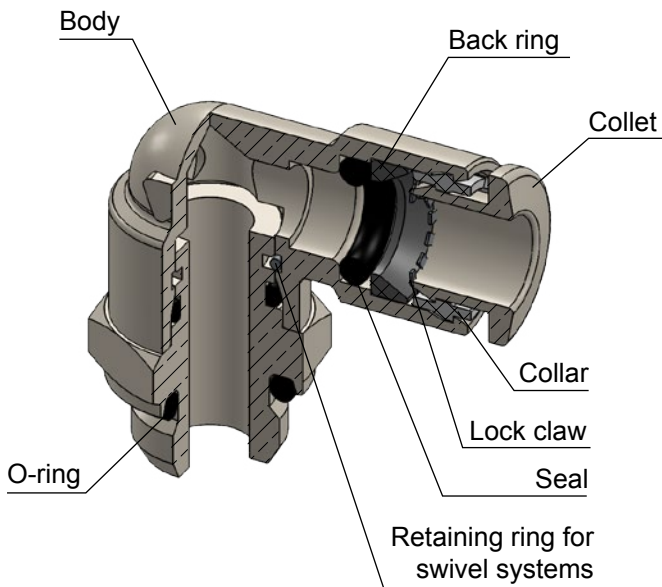

TIGHTENING TORQUE

TAPER GAS BSPT ISO 7 & NPT ANSI B 1.20.1

THREAD	1/8"	1/4"	3/8"	1/2"	1/8" NPT	1/4" NPT	3/8" NPT	1/2" NPT
Nm	10-12	14-16	16-18	18-20	3,5	4,5	7	12

TIGHTENING TORQUE

PARALLEL GAS BSPP ISO 228 & METRIC ISO 262

THREAD	M5x0,8	M7x1,0	1/8"	1/4"	3/8"	1/2"
Nm	1 ± 20%	3 ± 20%	6 ± 20%	7,5 ± 20%	9 ± 20%	9 ± 20%

INSERTION OF THE TUBE INTO THE FITTING

- Make sure the tube is fully inserted into the fitting.
- To insert the tube into the fitting cut the tube off square (90°), insert tube up to the fitting end stop, and pull back gently to make sure it is correctly connected.
- If there is any damage or scratches on the tube surface the tube is an oval shape, air leakage and tube release may occur. Check the tube condition carefully.
- The OD of polyurethane tube expands when pressure is applied. Reinsertion into the fitting may not always be possible. Check the OD of the tube and renew it the expansion is out of tolerance.

DISCONNECTION OF THE TUBE FROM THE FITTING

- Make sure the pressure in the system is zero before releasing the tube from the fitting.
- To release the tube, press the release sleeve towards the fitting with one hand (1) and pull the tube away from the fitting with the other hand (2).
- Always remove the section of tube previously inserted into the fitting before reinserting the tube by cutting back the tube. Always use the correct tube cutter in order to cut the tube square and free of damage.

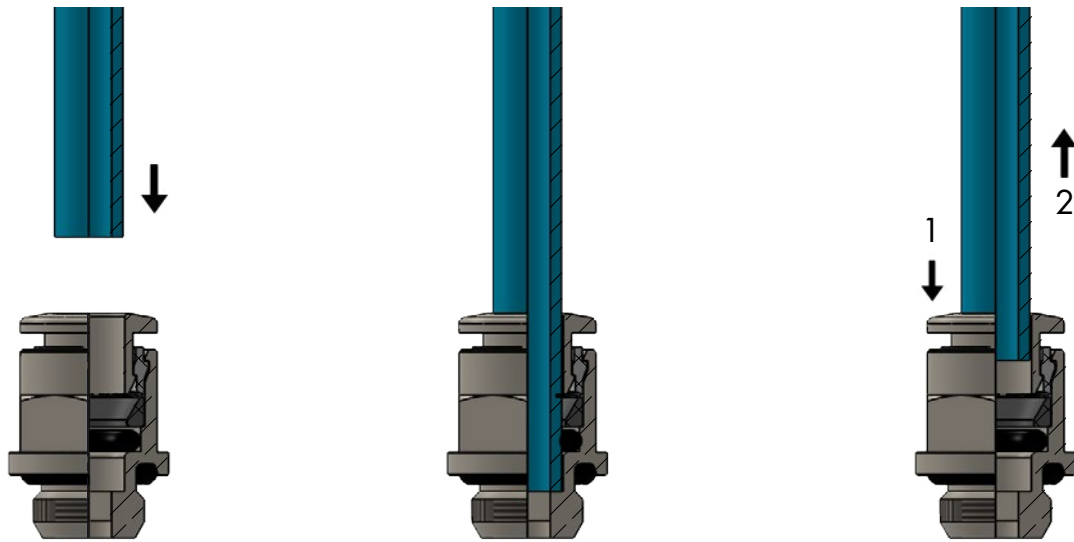

TOLERANCES - METRIC TUBE

Ø TUBE (mm)	4	6	8	10	12
TOLERANCE (mm)	± 0,1	± 0,1	± 0,1	± 0,15	± 0,15

INSERTION DEPTH - METRIC TUBE

Ø TUBE (mm)	4	6	8	10	12
TUBE INSERTION LENGHT (mm)	14	15,5	17,5	19	21

TOLERANCES - INCH TUBE

Ø TUBE (inch)	5/32"	1/4"	5/16"	3/8"	1/2"
TOLERANCE (mm)	±0,1	±0,1	±0,1	± 0,15	± 0,15

INSERTION DEPTH - INCH TUBE

Ø TUBE (inch)	5/32"	1/4"	5/16"	3/8"	1/2"
TUBE INSERTION LENGHT (mm)	14	16	17,5	18,5	21,5

OTRC-R

Male connector BSPT thread nickel-plated - metric tube

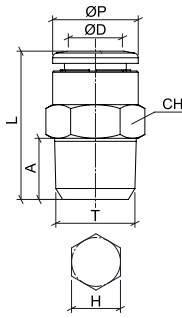

CODE	ØD	T	ØP	A	L	CH	H	g
OTRC04R01	4	R 1/8"	10	8	18,5	10	3	7,0
OTRC04R02		R 1/4"	10	10	20,0	14	3	15,4
OTRC06R01	6	R 1/8"	12	8	21,0	12	4	9,0
OTRC06R02		R 1/4"	12	10	20,5	14	4	14,0
OTRC08R01	8	R 1/8"	14	8	26,0	14	5	15,0
OTRC08R02		R 1/4"	14	10	24,0	14	6	15,0
OTRC08R03		R 3/8"	14	11	22,0	17	6	24,0
OTRC10R02	10	R 1/4"	16	10,5	30,0	16	7	22,0
OTRC10R03		R 3/8"	16	11	25,0	17	8	23,0
OTRC10R04		R 1/2"	16	14	25,5	22	8	45,0
OTRC12R02	12	R 1/4"	19	10	33,0	19	6	21,0
OTRC12R03		R 3/8"	19	11	29,5	19	10	27,0
OTRC12R04		R 1/2"	19	14	27,0	22	10	44,5

OTRC-G

Male connector BSPP & metric thread nickel-plated - metric tube

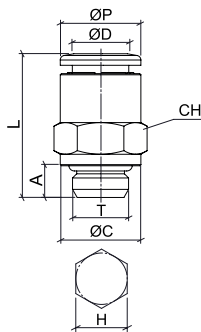

CODE	ØD	T	ØP	ØC	A	L	CH	H	g
OTRC04M5	4	M5x0,8	10	7	4	19,0	9	2,5	5,0
OTRC04G01		G 1/8"	10	14	5,5	18,0	10	3	8,0
OTRC04G02		G 1/4"	10	16	6,5	18,0	10	3	11,0
OTRC06M5	6	M5x0,8	12	7	4	21,0	11	2,5	8,0
OTRC06G01		G 1/8"	12	14	5,5	19,5	12	4	9,0
OTRC06G02		G 1/4"	12	16	6,5	19,5	12	4	12,0
OTRC08G01	8	G 1/8"	14	14	5,5	24,5	14	5	14,0
OTRC08G02		G 1/4"	14	16	6,5	21,5	14	6	13,5
OTRC08G03		G 3/8"	14	20	7,5	21,5	14	6	20,0
OTRC10G02	10	G 1/4"	16	16	6,5	27,5	16	7	19,0
OTRC10G03		G 3/8"	16	20	7,5	25,0	16	8	22,0
OTRC10G04		G 1/2"	16	25	9	25,0	16	8	33,0
OTRC12G02	12	G 1/4"	19	16	6,5	30,0	19	6	28,0
OTRC12G03		G 3/8"	19	22	7,5	29,5	19	10	30,0
OTRC12G04		G 1/2"	19	25	9	28,0	19	10	37,0

Male connector BSPP & metric thread nickel-plated - inch tube

CODE	ØD	T	ØP	ØC	A	L	CH	H	g
OTRC1-4M5	1/4"	M5x0,8	13	7	4	22,0	13	2,5	8,0
OTRC1-4G01		G 1/8"	13	13	5,5	20,0	13	4	9,0
OTRC38G03	3/8"	G 3/8"	16	20	7,5	25,0	16	8	22,0

OTRC-N

Male connector NPT thread nickel-plated - inch tube

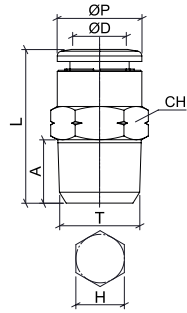

CODE	ØD	T	ØP	A	L	CH	H	g
OTRC532N01	5/32"	N 1/8"	10	8,5	19,0	7/16"	1/8"	9,0
OTRC532N02		N 1/4"	10	10,5	20,5	9/16"	1/8"	16,0
OTRC1-4N01	1/4"	N 1/8"	13	8,5	22,5	1/2"	3/16"	11,0
OTRC1-4N02		N 1/4"	13	10,5	22,5	9/16"	3/16"	15,0
OTRC516N01	5/16"	N 1/8"	14	8,5	27,0	9/16"	3/16"	15,5
OTRC516N02		N 1/4"	14	10,5	25,5	9/16"	1/4"	16,0
OTRC516N03		N 3/8"	14	11,5	23,5	11/16"	1/4"	25,0
OTRC38N01	3/8"	N 1/8"	16	8,5	29,0	11/16"	3/16"	21,5
OTRC38N02		N 1/4"	16	10,5	30,0	11/16"	1/4"	25,0
OTRC38N03		N 3/8"	16	11,5	26,0	11/16"	5/16"	24,0
OTRC38N04		N 1/2"	16	14,5	27,0	7/8"	5/16"	46,0
OTRC1-2N02	1/2"	N 1/4"	19	10,5	34,0	7/8"	1/4"	37,0
OTRC1-2N03		N 3/8"	19	11,5	34,5	7/8"	3/8"	39,0
OTRC1-2N04		N 1/2"	19	14,5	30,5	7/8"	3/8"	43,0

OTROC-G

Male connector round body metric thread nickel-plated - metric tube

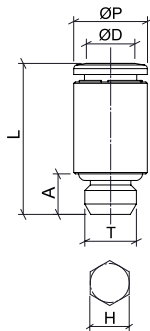

CODE	ØD	T	ØP	A	L	H	g
OTROC04M5	4	M5x0,8	10	4	19,0	2,5	-
OTROC04M6	4	M6x1	10	4,5	20,0	2,5	-
OTROC04M7	4	M7x1	10	5,5	20,5	2,5	-
OTROC06M5	6	M5x0,8	12	4	21,1	2,5	-
* OTROC06M7C	6	M7x1	10	5,5	20,5	4	-

* compact version

OTROC-N

Male connector round body UNF thread nickel-plated - inch tube

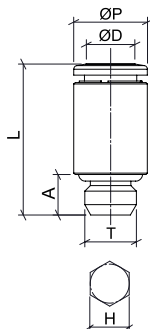

CODE	ØD	T	ØP	A	L	H	g
OTROC532UF1032	5/32"	UNF 10-32	0,393	0,157	0,748	3/32"	12,0
OTROC1-4UF1032	1/4"	UNF 10-32	0,511	0,157	0,846	3/32"	16,0

OTRCF-G

Female connector BSPP thread nickel-plated - metric tube

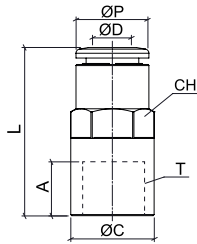

CODE	ØD	T	ØP	ØC	A	L	CH	g
OTRCF04G01	4	G 1/8"	10	13	7,5	24,5	10	-
OTRCF04G02		G 1/4"	10	16	11	28,5	10	-
OTRCF06G01	6	G 1/8"	12	13	7,5	26,1	12	-
OTRCF06G02		G 1/4"	12	16	11	29,6	12	-
OTRCF08G01	8	G 1/8"	14	13	7,5	27,2	14	-
OTRCF08G02		G 1/4"	14	16	11	32,2	14	-

OTRMM

Bulkhead connector nickel-plated - metric tube

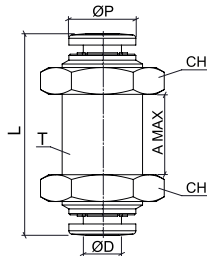

CODE	ØD	T	ØP	L	A MAX	CH	g
OTRMM04-532	4	M12x1	10	30,0	12	16	23,0
OTRMM0600	6	M14x1	12	35,5	15	17	31,0
OTRMM08-516	8	M16x1	14	36,5	16	19	36,0
OTRMM1000	10	M20x1	16	43,0	19	24	70,0
OTRMM1200	12	M22x1,5	19	44,0	20	25	76,0

Bulkhead connector nickel-plated - inch tube

CODE	ØD	T	ØP	L	A MAX	CH	g
OTRMM1-4	1/4"	M16x1	13	35,6	13	17	31,0
OTRMM38	3/8"	M20x1	16	42,5	17	24	70,0

OTRME

Male elbow BSPT thread nickel-plated - metric tube

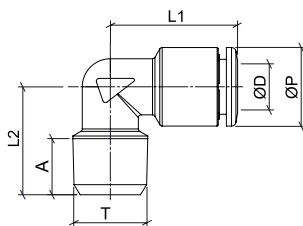

CODE	ØD	T	ØP	A	L1	L2	g
OTRME04R01	4	R 1/8"	10	8	18,0	15,5	11,0
OTRME06R01	6	R 1/8"	12	8	19,5	15,5	15,0
OTRME06R02		R 1/4"	12	10	20,5	19,0	20,0
OTRME08R01	8	R 1/8"	14	8	22,5	16,5	20,0
OTRME08R02		R 1/4"	14	10	22,5	19,0	24,0

OTRL-R

Swivel male elbow BSPT thread nickel-plated - metric tube

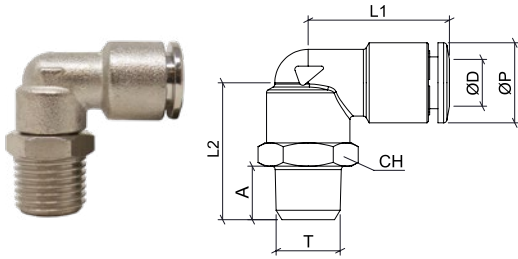

CODE	ØD	T	ØP	A	L1	L2	CH	g
OTRLO4R01	4	R 1/8"	10	8	19,5	20,5	13	20,0
OTRLO4R02		R 1/4"	10	10	19,5	23,0	14	23,0
OTRLO6R01	6	R 1/8"	12	8	21,0	20,5	13	20,0
OTRLO6R02		R 1/4"	12	10	21,0	23,0	14	24,0
OTRLO8R01	8	R 1/8"	14	8	23,0	20,5	13	22,0
OTRLO8R02		R 1/4"	14	10	23,0	23,0	14	26,0
OTRLO8R03		R 3/8"	14	11	23,0	24,5	17	32,0
OTRLO10R02	10	R 1/4"	16	10	26,0	25,5	16	41,0
OTRLO10R03		R 3/8"	16	11	26,0	27,0	17	45,0
OTRLO10R04		R 1/2"	16	14	26,0	30,0	22	59,0
OTRLO12R02	12	R 1/4"	19	10	31,0	28,0	20	56,0
OTRLO12R03		R 3/8"	19	11	31,0	28,5	20	59,0
OTRLO12R04		R 1/2"	19	14	31,0	31,5	22	70,0

OTRL-G

Swivel male elbow BSPP & metric thread nickel-plated - metric tube

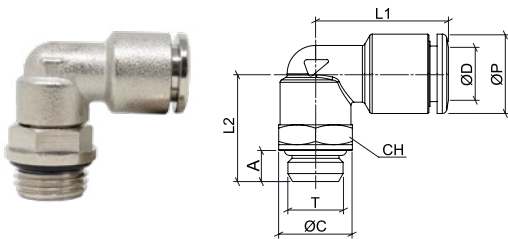

CODE	ØD	T	ØP	ØC	A	L1	L2	CH	g
OTRLO4M5	4	M5x0,8	10	7	4	18,0	15,0	8	5,0
OTRLO4G01		G 1/8"	10	13	5,5	19,5	19,0	13	19,0
OTRLO4G02		G 1/4"	10	16	6,5	19,5	21,5	13	22,0
OTRLO6M5	6	M5x0,8	12	7	4	19,5	16,0	8	11,0
OTRLO6G01		G 1/8"	12	13	5,5	21,0	19,0	13	20,0
OTRLO6G02		G 1/4"	12	16	6,5	21,0	21,5	13	24,0
OTRLO8G01	8	G 1/8"	14	13	5,5	23,0	19,0	13	22,0
OTRLO8G02		G 1/4"	14	16	6,5	23,0	21,5	13	24,0
OTRLO8G03		G 3/8"	14	20	7,5	23,0	23,0	13	28,0
OTRLO10G02	10	G 1/4"	16	16	6,5	26,0	23,0	16	35,0
OTRLO10G03		G 3/8"	16	20	7,5	26,0	26,0	16	43,5
OTRLO10G04		G 1/2"	16	25	9	26,0	27,5	16	52,0
OTRLO12G02	12	G 1/4"	19	16	6,5	31,0	25,5	20	55,0
OTRLO12G03		G 3/8"	19	20	7,5	31,0	26,5	20	55,0
OTRLO12G04		G 1/2"	19	25	9	31,0	29,0	20	63,0

Swivel male elbow BSPP thread nickel-plated - inch tube

CODE	ØD	T	ØP	ØC	A	L1	L2	CH	g
OTRLO1-4G01	1/4"	G 1/8"	13	13	5,5	22,0	19,0	13	20,0
OTRLO1-4G02		G 1/4"	13	16	6,5	22,0	21,5	13	24,0
OTRLO3-8G02	3/8"	G 1/4"	16	16	6,5	26,0	23,0	16	35,0
OTRLO3-8G03		G 3/8"	16	20	7,5	26,0	26,0	16	43,5

OTRL-N

Swivel male elbow NPT & UNF thread nickel-plated - inch tube

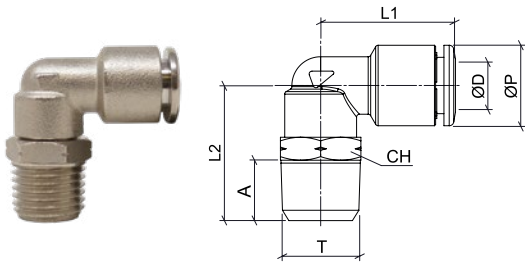

CODE	ØD	T	ØP	A	L1	L2	CH	g
OTRL532UF1032	5/32"	UNF 10/32"	10	4	18,0	15,0	3/8"	11,0
OTRL532N01		N 1/8"	10	8,5	19,5	21,0	9/16"	20,5
OTRL532N02		N 1/4"	10	10,5	19,5	23,5	9/16"	24,0
OTRL1-4N01	1/4"	N 1/8"	13	8,5	21,5	21,0	9/16"	23,0
OTRL1-4N02		N 1/4"	13	10,5	21,5	23,5	9/16"	26,0
OTRL516N01	5/16"	N 1/8"	14	8,5	23,5	21,0	9/16"	23,0
OTRL516N02		N 1/4"	14	10,5	23,5	23,5	9/16"	24,0
OTRL516N03		N 3/8"	14	11,5	23,5	25,0	11/16"	34,0
OTRL38N01	3/8"	N 1/8"	16	8,5	26,0	24,0	11/16"	40,0
OTRL38N02		N 1/4"	16	10,5	26,0	26,0	11/16"	43,0
OTRL38N03		N 3/8"	16	11,5	26,0	27,5	11/16"	47,0
OTRL38N04		N 1/2"	16	14,5	26,0	30,5	7/8"	60,0
OTRL1-2N02	1/2"	N 1/4"	19	10,5	31,0	28,5	7/8"	58,0
OTRL1-2N03		N 3/8"	19	11,5	31,0	29,5	7/8"	61,0
OTRL1-2N04		N 1/2"	19	14,5	31,0	32,5	7/8"	67,0

OTRLF-G

Swivel female elbow BSPP thread nickel-plated - metric tube

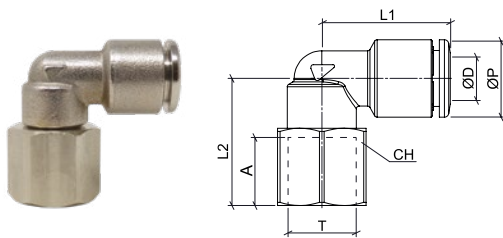

CODE	ØD	T	ØP	A	L1	L2	CH	g
OTRLF04G01	4	G 1/8"	10	7,5	19,5	19,2	13	-
OTRLF06G01	6	G 1/8"	12	7,5	21,1	19,0	13	-
OTRLF06G02		G 1/4"	12	11	21,1	23,0	16	-
OTRLF08G01	8	G 1/8"	14	7,5	23,2	19,0	13	-
OTRLF08G02		G 1/4"	14	11	23,2	23,0	16	-

OTRT-R

Swivel male tee BSPT thread nickel-plated - metric tube

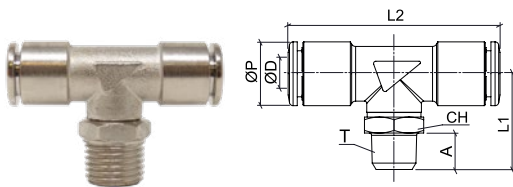

CODE	ØD	T	ØP	A	L1	L2	CH	g
OTRT04R01	4	R 1/8"	10	8	21,0	39,0	13	27,0
OTRT04R02		R 1/4"	10	10	23,5	39,0	14	31,0
OTRT06R01	6	R 1/8"	12	8	21,0	42,0	13	30,0
OTRT06R02		R 1/4"	12	10	23,5	42,0	14	34,0
OTRT08R01	8	R 1/8"	14	8	21,0	46,5	13	34,0
OTRT08R02		R 1/4"	14	10	23,5	46,5	14	37,0
OTRT08R03		R 3/8"	14	11	24,0	46,5	17	44,0
OTRT10R02	10	R 1/4"	16	10	25,5	52,0	16	55,0
OTRT10R03		R 3/8"	16	11	27,0	52,0	17	58,5
OTRT10R04		R 1/2"	16	14	30,0	52,0	22	73,0
OTRT12R02	12	R 1/4"	19	10	28,0	62,0	20	77,0
OTRT12R03		R 3/8"	19	11	28,5	62,0	20	80,0
OTRT12R04		R 1/2"	19	14	31,5	62,0	22	81,0

OTRT-G

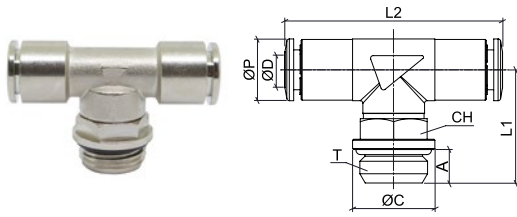

Swivel male tee BSPP & metric thread nickel-plated - metric tube

CODE	ØD	T	ØP	ØC	A	L1	L2	CH	g
OTRT04M5	4	M5x0,8	10	7	4	17,0	32,0	8	17,0
OTRT04G01		G 1/8"	10	13	5,5	19,5	39,0	13	29,0
OTRT04G02		G 1/4"	10	16	6,5	22,0	39,0	13	29,0
OTRT06M5	6	M5x0,8	12	7	4	17,0	40,0	8	21,0
OTRT06G01		G 1/8"	12	13	5,5	19,5	42,0	13	29,0
OTRT06G02		G 1/4"	12	16	6,5	22,0	42,0	13	32,0
OTRT08G01	8	G 1/8"	14	13	5,5	19,5	46,5	13	33,0
OTRT08G02		G 1/4"	14	16	6,5	22,0	46,5	13	35,5
OTRT08G03		G 3/8"	14	20	7,5	23,5	46,5	13	39,0
OTRT10G02	10	G 1/4"	16	16	6,5	23,0	52,0	16	52,0
OTRT10G03		G 3/8"	16	20	7,5	26,0	52,0	16	56,0
OTRT10G04		G 1/2"	16	25	9	27,5	52,0	16	64,5
OTRT12G02	12	G 1/4"	19	16	6,5	25,5	62,0	20	75,0
OTRT12G03		G 3/8"	19	20	7,5	26,5	62,0	20	77,0
OTRT12G04		G 1/2"	19	25	9	29,0	62,0	20	82,0

Swivel male tee BSPP thread nickel-plated - inch tube

CODE	ØD	T	ØP	ØC	A	L1	L2	CH	g
OTRT1-4G01	1/4"	G 1/8"	13	13	5,5	19,5	42,5	13	29,0
OTRT1-4G02		G 1/4"	13	16	6,5	22,0	42,5	13	32,0
OTRT38G02	3/8"	G 1/4"	16	16	6,5	23,0	51,5	16	52,0
OTRT38G03		G 3/8"	16	20	7,5	26,0	51,5	16	56,0

OTRT-N

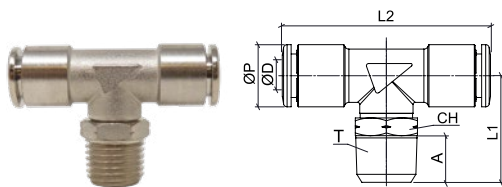

Swivel male tee NPT & UNF thread nickel-plated - inch tube

CODE	ØD	T	ØP	A	L1	L2	CH	g
OTRT532UF1032	5/32"	UNF 10-32"	10	4	17,0	32,0	3/8"	17,0
OTRT532N01		N 1/8"	10	8,5	21,5	39,0	9/16"	28,0
OTRT532N02		N 1/4"	10	10,5	24,0	39,0	9/16"	31,0
OTRT1-4N01	1/4"	N 1/8"	13	8,5	21,5	42,5	9/16"	33,0
OTRT1-4N02		N 1/4"	13	10,5	24,0	42,5	9/16"	36,0
OTRT516N01	5/16"	N 1/8"	14	8,5	21,5	47,0	9/16"	34,0
OTRT516N02		N 1/4"	14	10,5	24,0	47,0	9/16"	37,0
OTRT38N02	3/8"	N 1/4"	16	10,5	26,0	51,5	11/16"	58,0
OTRT38N03		N 3/8"	16	11,5	27,5	51,5	11/16"	61,0
OTRT1-2N02	1/2"	N 1/4"	19	10,5	28,5	62,5	7/8"	75,0
OTRT1-2N03		N 3/8"	19	11,5	29,5	62,5	7/8"	78,0

OTRST-R

Swivel male lateral tee BSPT thread nickel-plated - metric tube

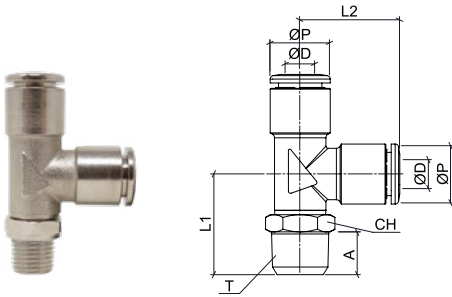

CODE	ØD	T	ØP	A	L1	L2	CH
OTRST04R01	4	R 1/8"	10	8	21,0	19,5	13
OTRST04R02		R 1/4"	10	10	23,5	19,5	14
OTRST06R01	6	R 1/8"	12	8	21,0	21,0	13
OTRST06R02		R 1/4"	12	10	23,5	21,0	14
OTRST08R01	8	R 1/8"	14	8	21,0	23,0	13
OTRST08R02		R 1/4"	14	10	23,5	23,0	14
OTRST10R02	10	R 1/4"	16	10	25,5	26,0	16
OTRST10R03		R 3/8"	16	11	27,0	26,0	17
OTRST12R03	12	R 3/8"	19	11	37,0	29,0	20
OTRST12R04		R 1/2"	19	14	40,0	29,0	22

OTRST-G

Swivel male lateral tee BSPP thread nickel-plated - metric tube

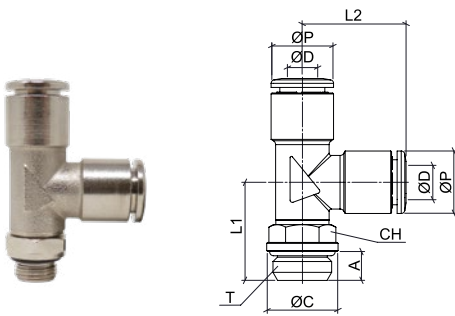

CODE	ØD	T	ØP	ØC	A	L1	L2	CH
OTRST04G01	4	G 1/8"	10	13	5,5	19,5	19,5	13
OTRST04G02		G 1/4"	10	16	6,5	22,0	19,5	13
OTRST06G01	6	G 1/8"	12	13	5,5	19,5	21,0	13
OTRST06G02		G 1/4"	12	16	6,5	22,0	21,0	13
OTRST08G01	8	G 1/8"	14	13	5,5	19,5	23,0	13
OTRST08G02		G 1/4"	14	16	6,5	22,0	23,0	13
OTRST10G02	10	G 1/4"	16	16	6,5	23,0	26,0	16
OTRST10G03		G 3/8"	16	20	7,5	26,0	26,0	16
OTRST12G03	12	G 3/8"	19	20	7,5	35,0	29,0	20
OTRST12G04		G 1/2"	19	25	9	37,0	29,0	20

OTRA-G

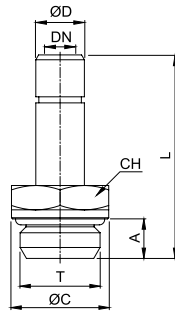

Stem adapter BSPP & metric thread nickel-plated - metric tube

CODE	ØD	T	ØC	A	L	CH	DN	g
OTRA04M5	4	M5x0,8	7	4	24,5	8	2,0	3,0
OTRA04M7		M7x1	10	5,5	27,0	10	2,0	5,0
OTRA04G01		G 1/8"	13	5,5	27,0	13	2,0	10,0
OTRA04G02		G 1/4"	16	6,5	29,5	13	2,0	11,0
OTRA06M5	6	M5x0,8	7	4	25,5	8	2,5	5,0
OTRA06M7		M7x1	10	5,5	27,0	10	4,0	7,0
OTRA06G01		G 1/8"	13	5,5	28,0	13	4,0	9,0
OTRA06G02	G 1/4"	16	6,5	30,5	13	4,0	13,0	
OTRA08G01	8	G 1/8"	13	5,5	29,5	13	6,0	10,0
OTRA08G02		G 1/4"	16	6,5	32,0	13	6,0	13,0
OTRA08G03		G 3/8"	20	7,5	33,5	13	6,0	21,0
OTRA10G01	10	G 1/8"	13	5,5	34,0	13	8,0	17,0
OTRA10G02		G 1/4"	16	6,5	36,5	13	8,0	15,0
OTRA10G03		G 3/8"	20	7,5	37,5	16	8,0	26,0
OTRA12G02	12	G 1/4"	16	6,5	37,5	13	8,5	22,0
OTRA12G03		G 3/8"	20	7,5	41,5	16	10,0	22,0
OTRA12G04		G 1/2"	25	9	43,0	20	10,0	35,0

OTRUC

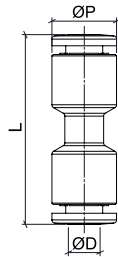

Union connector nickel-plated - metric tube

CODE	ØD	ØP	L	g
OTRUC04-532	4	10	29,0	9,0
OTRUC0600	6	12	32,0	12,0
OTRUC08-516	8	14	36,0	16,0
OTRUC1000	10	16	39,0	21,0
OTRUC1200	12	19	44,5	37,0

Union connector nickel-plated - inch tube

CODE	ØD	ØP	L	g
OTRUC04-532	5/32"	10	29,0	9,0
OTRUC1-4	1/4"	13	33,0	14,0
OTRUC08-516	5/16"	14	35,5	16,0
OTRUC38	3/8"	16	38,5	21,0
OTRUC1-2	1/2"	19	44,5	37,0

OTRUL

Union elbow nickel-plated - metric tube

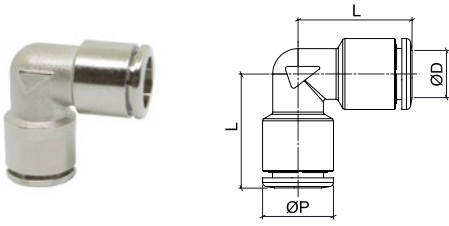

CODE	ØD	ØP	L	g
OTRUL04-532	4	10	18,0	12,0
OTRUL0600	6	12	19,5	14,0
OTRUL08-516	8	14	22,5	20,0
OTRUL1000	10	16	25,5	26,0
OTRUL1200	12	19	29,0	49,0

Union elbow nickel-plated - inch tube

CODE	ØD	ØP	L	g
OTRUL04-532	5/32"	10	18,0	12,0
OTRUL1-4	1/4"	13	21,0	19,0
OTRUL08-516	5/16"	14	22,5	20,0
OTRUL38	3/8"	16	25,0	28,0
OTRUL1-2	1/2"	19	29,0	49,0

OTRUT

Union tee nickel-plated - metric tube

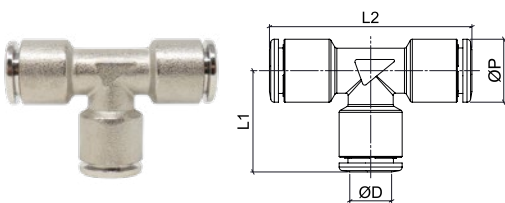

CODE	ØD	ØP	L1	L2	g
OTRUT04-532	4	10	18,0	36,0	17,0
OTRUT0600	6	12	19,5	39,0	20,0
OTRUT08-516	8	14	22,5	45,5	30,0
OTRUT1000	10	16	25,5	50,5	37,0
OTRUT1200	12	19	29,0	58,5	68,0

Union tee nickel-plated - inch tube

CODE	ØD	ØP	L1	L2	g
OTRUT04-532	5/32"	10	18,0	36,0	17,0
OTRUT1-4	1/4"	13	21,0	42,0	27,0
OTRUT08-516	5/16"	14	22,5	45,5	30,0
OTRUT38	3/8"	16	25,0	50,5	38,0
OTRUT1-2	1/2"	19	29,0	58,0	59,0

OTRY

Union Y nickel-plated - metric tube

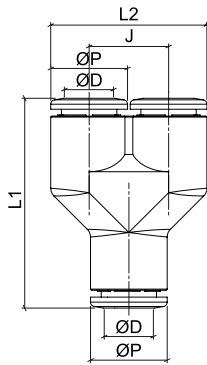

CODE	ØD	ØP	J	L1	L2	g
OTRY04	4	10	10,5	32,0	20,5	
OTRY06	6	12	12,5	35,5	24,5	
OTRY08	8	14	14,5	38,5	28,5	
OTRY10	10	16	17,0	45,5	33,0	
OTRY12	12	19	20,0	52,5	39,0	

OTRGJ

Stem reduction nickel-plated - metric tube

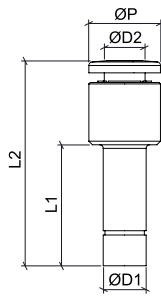

CODE	ØD1	ØD2	ØP	L1	L2	g
OTRGJ0604	6	4	10	18,0	30,0	6,0
OTRGJ0804	8	4	10	19,5	32,0	
OTRGJ0806	8	6	12	19,5	32,5	10,0
OTRGJ1006	10	6	12	24,0	37,0	
OTRGJ1008	10	8	14	24,0	38,0	13,0
OTRGJ1208	12	8	14	25,0	39,0	
OTRGJ1210	12	10	16	25,0	41,0	18,0

